

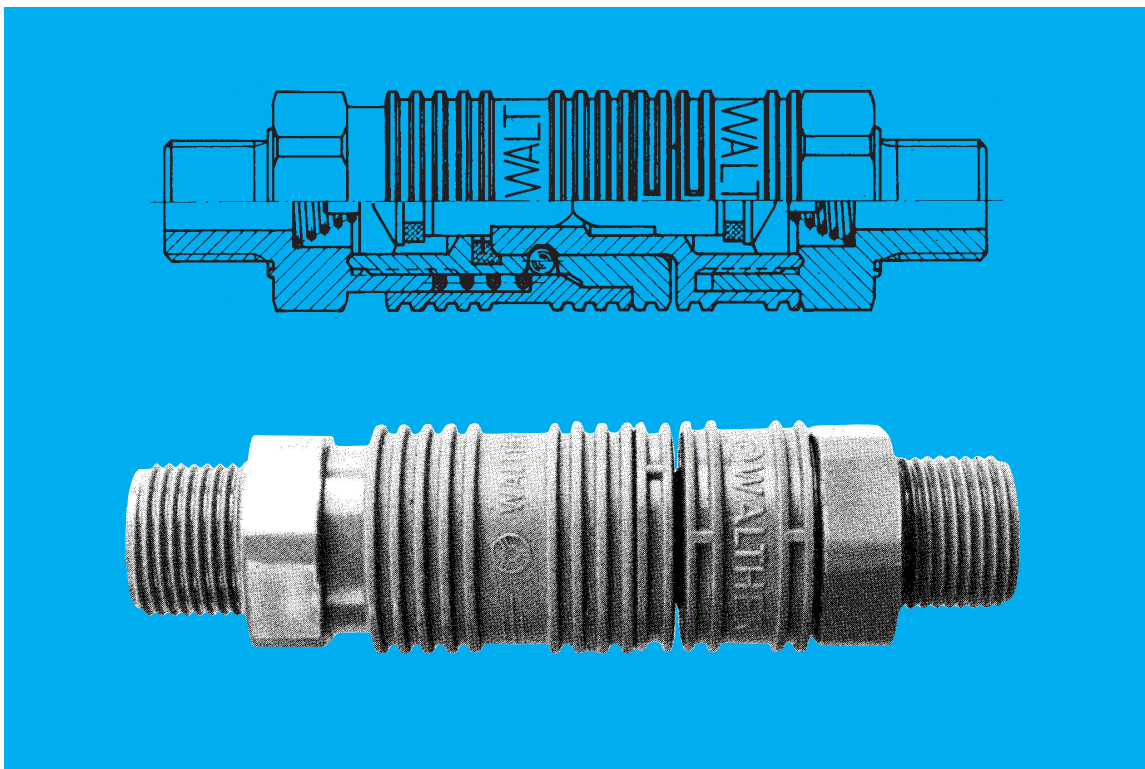

Nom. bore	Type	Material pressure at 20° C	Max. static working		C _v value		Cross section [mm ²]	Page
			both sides [bar]	one side [psi]	both sides self sealing	one side self sealing		
6	KL-006	polyamide 11/12 grey (PA)	12	170	0.73	1.0	30	36
12	KL-012	polyacetal grey (POM)	10	145	2.32	3.1	120	37
30	KL-030	polyacetal resin (POM)	10	145	23.3	30.46	710	38
Threaded hose connectors, double and reducing connectors								38
Performance diagrams								39 - 40

Series KL

Materials: other materials e. g. PVDF, PP, ... as special types on request



Series KL

Type KL-012

Nom. Bore 12 mm 37

characteristic features:
- can be coupled with type LP-012

special version:
Z01 = for partial vacuum couplings with O-ring seal

optional features:
OV = without valve
SI = with additional axial safety lock (outer diameter 44 mm)

materials:
standard:
40 = polyacetal resin POM, grey

special materials:
other materials as special types on request

seal qualities:
1 = NBR
2 = FKM
4 = EPDM

Please note the technical data on pages 2 - 7, 39 - 40 and the max. working pressures on page 35

Availability: ● Short ◐ Medium ○ Long

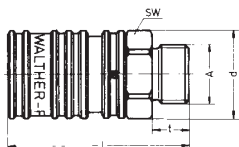
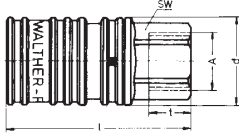
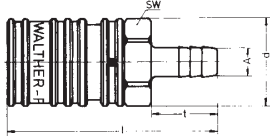
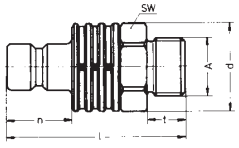
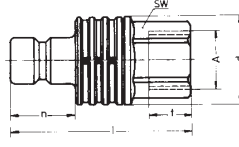
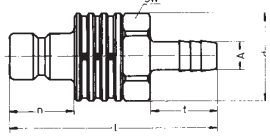
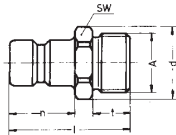
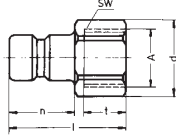
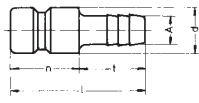
	Part No.	Connection A	PA grey						d	SW	l	t	n	weight [g]
Self sealing couplings	 <p>British standard pipe parallel (BSPP) male thread to DIN ISO 228</p>	KL-012-0-WR021-40-.	BSPP 1/2"	●				40	30	88	15		90	
		KL-012-0-WR026-40-.	BSPP 3/4"	○				40	30	90	17		90	
	 <p>British standard pipe parallel (BSPP) female thread to DIN ISO 228</p>	KL-012-0-WR521-40-.	BSPP 1/2"	●				30	82,5	15	17		85	
	KL-012-0-WR526-40-.	BSPP 3/4"	○				30	84,5	17	19		90		
	 <p>hose tailpiece with hose nozzle</p>	KL-012-0-SL016-40-.	16 mm	●				40	30	98	35		90	
		KL-012-0-SL019-40-.	19 mm	●				40	30	102	35		90	
Self sealing adaptors	 <p>British standard pipe parallel (BSPP) male thread to DIN ISO 228</p>	KL-012-2-WR021-40-.	BSPP 1/2"	●				40	30	86	15	29,5	60	
		KL-012-2-WR026-40-.	BSPP 3/4"	○				40	30	88	17	29,5	60	
	 <p>British standard pipe parallel (BSPP) female thread to DIN ISO 228</p>	KL-012-2-WR521-40-.	BSPP 1/2"	●				40	30	82,5	15	29,5	55	
	KL-012-2-WR526-40-.	BSPP 3/4"	○				40	30	82,5	17	29,5	60		
	 <p>hose tailpiece with hose nozzle</p>	KL-012-2-SL016-40-.	16 mm	●				40	30	96	35	29,5	58	
		KL-012-2-SL019-40-.	19 mm	●				40	30	100	35	29,5	62	
Thru type adaptors	 <p>British standard pipe parallel (BSPP) male thread to DIN ISO 228</p>	KL-012-1-WR021-40	BSPP 1/2"	●				33,1	30	54,5	15	29,5	17	
		KL-012-1-WR026-40	BSPP 3/4"	○				33,1	30	56,5	17	29,5	23	
	 <p>British standard pipe parallel (BSPP) female thread to DIN ISO 228</p>	KL-012-1-WR521-40	BSPP 1/2"	○				33,1	30	49	15	29,5	18	
	KL-012-1-WR526-40	BSPP 3/4"	○				33,1	30	51	17	29,5	23		
	 <p>hose tailpiece with hose nozzle</p>	KL-012-1-SL013-40	13 mm	●				21		59,5	30	29,5	13	
KL-012-1-SL016-40		16 mm	●				21		69,5	35	29,5	13		
KL-012-1-SL019-40		19 mm	○				25		68,5	35	29,5	18		

Series KL